



AUTHENTICS 300



OWNER'S MANUAL

IMPORTANT SAFETY INSTRUCTIONS

Verify Line Voltage Before Use

The JBL Authentics speaker has been designed for use with 100-240 volt, 50/60 Hz AC current. Connection to a line voltage other than that for which your product is intended can create a safety and fire hazard and may damage the unit. If you have any questions about the voltage requirements for your specific model or about the line voltage in your area, contact your retailer or customer service representative before plugging the unit into a wall outlet.

Do Not Use Extension Cords

To avoid safety hazards, use only the power cord supplied with your unit. We do not recommend that extension cords be used with this product. As with all electrical devices, do not run power cords under rugs or carpets, or place heavy objects on them. Damaged power cords should be replaced immediately by an authorized service center with a cord that meets factory specifications.

Handle the AC Power Cord Gently

When disconnecting the power cord from an AC outlet, always pull the plug; never pull the cord. If you do not intend to use this speaker for any considerable length of time, disconnect the plug from the AC outlet.

Do Not Open the Cabinet

There are no user-serviceable components inside this product. Opening the cabinet may present a shock hazard, and any modification to the product will void your warranty. If water accidentally falls inside the unit, disconnect it from the AC power source immediately, and consult an authorized service center.

TABLE OF CONTENTS

IMPORTANT SAFETY INSTRUCTIONS 2

1. INTRODUCTION 4

- 1.1 JBL One app 4
 - 1.2 Voice Control 4
-

2. WHAT'S IN THE BOX 5

3. PRODUCT OVERVIEW 5

- 3.1 Front panel & Top panel 5
 - 3.2 Back panel 6
-

4. POWER ON / OFF 7

- 4.1 AC-powered mode 7
 - 4.2 Battery mode 7
-

5. CONNECT 8

- 5.1 Connect to your home network 8
 - 5.2 Connect to your Bluetooth device 9
 - 5.3 Connect to an external audio device 9
-

6. VOICE ASSISTANTS 10

- 6.1 Set up your voice assistants 10
 - 6.2 Talk to your voice assistants 10
-

7. PLAY 11

- 7.1 Play over your home network 11
- 7.2 Play from the Bluetooth source 13
- 7.3 Control music playback 13
- 7.4 Play from the AUX source 13

8. SETTINGS 14

- 8.1 Sound settings 14
 - 8.2 Software upgrade 14
 - 8.3 Hard reset 14
 - 8.4 Restore factory settings 14
-

9. PRODUCT SPECIFICATIONS 15

10. TROUBLESHOOTING 15

11. TRADEMARKS 17

12. OPEN SOURCE LICENSE NOTICE 18

1. INTRODUCTION

Thank you for purchasing the JBL Authentics speaker. We encourage you to take a few minutes to read through this manual, which describes the product and includes step-by-step instructions for setting up and getting started.

To make the most of product features and support, you may need to update the product software through the Internet in the future. Refer to the software update section in this manual to ensure that your product has the latest software.

Designs and specifications are subject to change without notice. If you have any questions about the speaker, installation or operation, please contact your retailer or customer service representative, or visit our website: www.jbl.com.

1.1 JBL One app

With the JBL One app, you can

- easily connect the speaker to your Wi-Fi network;
- set up your voice assistants;
- connect *music streaming services;
- personalize audio settings;
- manage and control devices;
- access additional features.

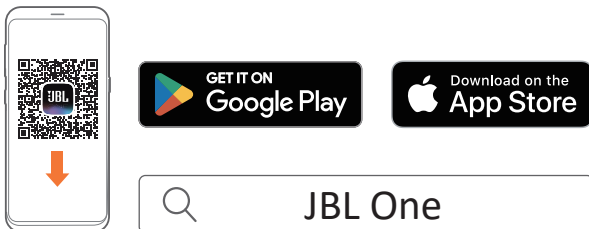

For more information, see [“5.1 Connect to your home network”](#) and [“7.1 Play over your home network”](#).

NOTE:

- *Subscription may be needed and not provided by the JBL One app.

1.2 Voice Control

With Google Assistant and Amazon Alexa available simultaneously, you can play your favorite music, control your smart home devices, and more, hands-free, using just your voice. You can access both assistants simultaneously on this device.

For how to set up and use your voice assistants, see [“6. VOICE ASSISTANTS”](#).

2. WHAT'S IN THE BOX

Unpack the box carefully and ensure that the following parts are included. If any part is damaged or missing, do not use it and contact your retailer or customer service representative.

Speaker

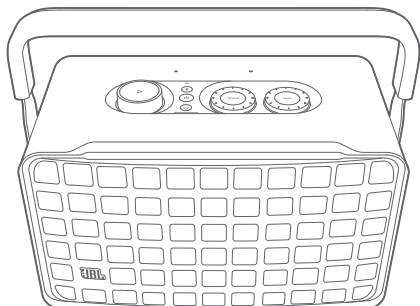

Power cord*

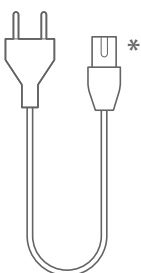

* Power cord quantity and plug type vary by regions.

Product information



3. PRODUCT OVERVIEW

3.1 Front panel & Top panel

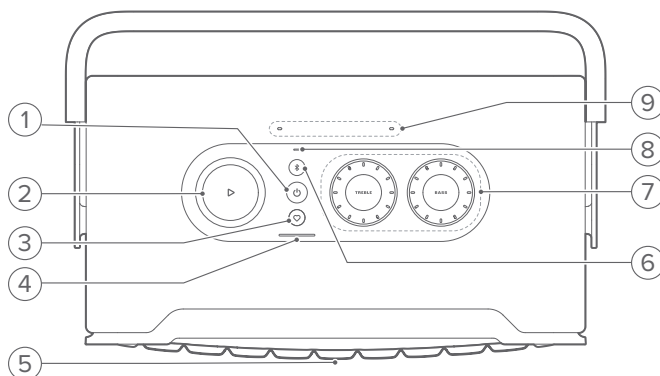

- 1)
 - Press to switch on or off.
 - Hold for more than 10 seconds to reset the speaker.
- 2)

(Playback controls while streaming music from the JBL One app, Chromecast built-in™, AirPlay, Alexa Multi-Room Music, Alexa Cast or Bluetooth)

 - Press once to play or pause playback.
 - Press twice to play the next track.
 - Press three times to play the previous track.

(Rotary volume controls)

 - Rotate clockwise or counter-clockwise to increase or decrease the volume.
- 3) **(Moment)**
 - Press to directly access your music playlist and speaker settings that you have personalized in the JBL One app.

4) Battery indicator

	Flashing (red)	Low battery
	Flashing (white)	Charging in process
	Solid (white)	Current battery level
	Off	Charging complete

5) Voice assistant status LED

State	Google Assistant		Amazon Alexa	
Activated and Listening		Solid (white)		Solid loop (cyan and blue)
Thinking		Fast pulsing (white)		Fast loop (cyan and blue)
Responding		Fast pulsing (white)		Alternating loop (cyan and blue)
Microphone Off		Solid (red)		Solid (red)

6) Bluetooth

- Press to enter Bluetooth pairing mode.
- Status indicator

	Fast flashing (white)	Bluetooth pairing
	Solid (white)	Bluetooth connected
	Off	Bluetooth not connected

7) Tone controls

TREBLE



- Rotate clockwise or counter-clockwise to increase or decrease the treble level.

BASS





- Rotate clockwise or counter-clockwise to increase or decrease the bass level.

8) Status indicator











System:

	Regular pulsing (white)	System startup
	Fast pulsing (white)	Software updating in progress
	Solid (amber)	Restoring factory settings

Network connection:

	Slow pulsing (white)	Entering Wi-Fi setup mode, or network disconnected
	Solid (green)	Speaker discovered by the JBL One app
	Solid (white)	Network connected
	Solid (yellow)	Weak Wi-Fi connection

Voice assistant notifications:

State	Google Assistant		Amazon Alexa*	
Timer Ringing		Slow pulsing (white)	 (1H)	Cyan and blue for 1 hour
				Turns off when the timer is deactivated
Alarm Ringing		Slow pulsing (white)	 (1H)	Cyan and blue for 1 hour
				Turns off when the alarm is deactivated
Reminder		Solid white for about 10 minutes	 x2	Cyan and blue twice, followed by voice response
Queued Notifications		Solid white for about 10 minutes		Slow pulsing (yellow)
Do Not Disturb Mode Enabled	/	N/A		Pulses once (purple)

* To dismiss Alexa's alarm, timer or other notifications, press  on the speaker.

9) Microphones

- For voice control and automatic self-tuning.

3.2 Back panel



1) POWER

- Connect to power (with the supplied power cord).

2) USB

- USB connector for software update (for technical personnel only).
- Connect to a USB storage device for MP3 file playback (for US version only).

3) AUX



- Connect to the audio output on an external device through a 3.5 mm audio cable.

4) ETHERNET

- Connect to your home network through an Ethernet cable.

5) (Voice assistant microphone)

- Move the slider to turn the microphone on or off.

	Microphone off
	Microphone on

4. POWER ON / OFF

4.1 AC-powered mode

4.1.1 Connect power

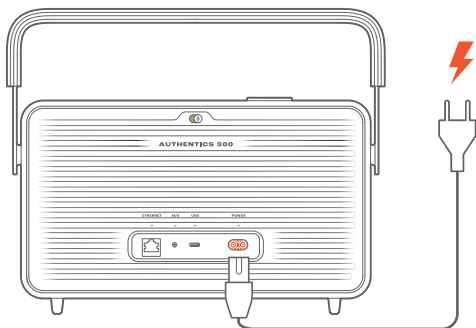

- Connect the speaker to power by using the supplied power cord.

4.1.2 Switch on

- To switch on, press $\text{\textcircled{P}}$.

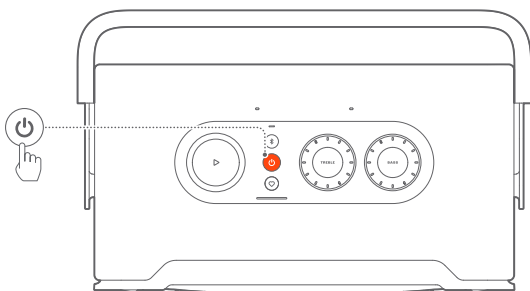

4.1.3 Auto standby

If the speaker is inactive for more than 10 minutes, it will switch to standby mode automatically.

4.1.4 Auto wakeup

In standby mode, the speaker will wake up automatically when

- you press any button on the speaker;
- the speaker is connected to your home network and you control the setup and playback on the speaker through the JBL One app;
- the speaker is connected to your home network and you wake up the speaker through an enabled voice assistant;
- the speaker is connected to your home network and audio is streamed to the speaker through the supported streaming services that you have enabled in the JBL One app;
- an audio cable has been inserted into the speaker and music playback has started from the external device connected through the audio cable.

4.2 Battery mode

4.2.1 Charge the battery

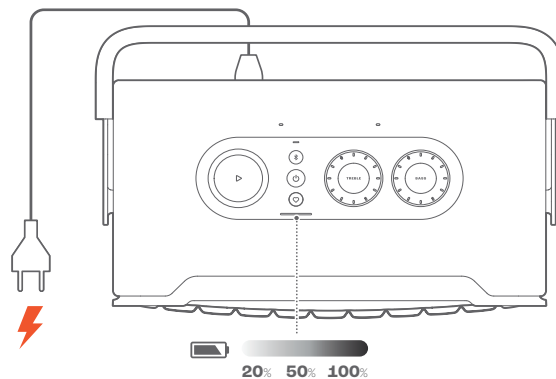

- Connect the speaker to power by using the supplied power cord.
→ Battery charging starts automatically.

4.2.2 Power-saving mode

In the battery mode, the speaker automatically powers off after 1 hour of inactivity to save power. Press $\text{\textcircled{P}}$ to switch on.

NOTES:



- To avoid draining the battery, switch off the speaker if it is not going to be used for a long time.
- You can set the auto power-off time in the JBL One app.

5. CONNECT



5.1 Connect to your home network

Using Wi-Fi or an Ethernet cable, connect the speaker to your network. When you register Google Assistant and Amazon Alexa, you can use your voice to get hands-free help or control your smart home devices. This also enables Chromecast built-in, Alexa Multi-Room Music, and Alexa Cast. Or, with the JBL One app and the supported streaming services (AirPlay and Spotify Connect), the speaker allows you to stream music from smartphones or tablets (See [7.1 Play over your home network](#)).

5.1.1 Wi-Fi connection with your home network

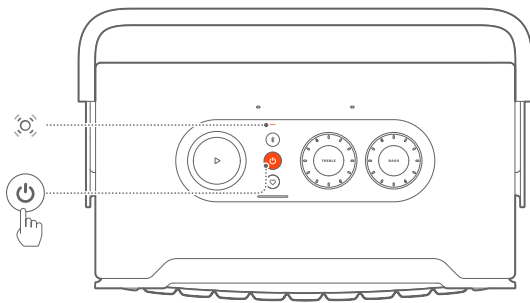

1. On the speaker, enter the Wi-Fi setup mode:
 - Press  to switch on.
 -  (Slow pulsing white): The speaker enters Wi-Fi setup mode.

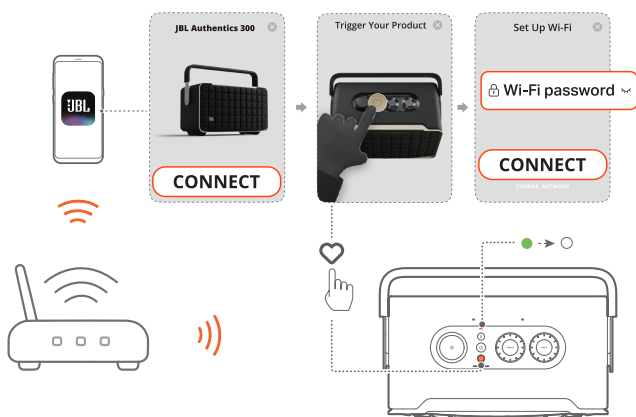

2. Connect your Android™ or iOS device to your home Wi-Fi network. Download the JBL One app.
3. Launch the JBL One app. Follow the app instructions to complete Wi-Fi and voice assistant setup.
 -  (Solid green): The speaker is discovered by the JBL One app.
 -  (Solid white): The speaker is connected to your home network.
 - You can stream music from the JBL One app or the streaming services you have enabled in the JBL One app (See [7.1 Play over your home network](#)).



NOTES:

- Make sure that your speaker is connected to the same Wi-Fi network as your Android or iOS device.
- If your speaker is not discovered by the JBL One app, hold  and  together for more than 10 seconds to re-enter the Wi-Fi setup mode.
- To enable Chromecast built-in, Alexa Multi-Room Music, and Alexa Cast, please register Google Assistant and Amazon Alexa on the Google Home app and Amazon Alexa app respectively.

5.1.2 Wired connection with your home network through an Ethernet cable (Optional)

1. Use an Ethernet cable (not supplied) to connect the speaker to your home network.

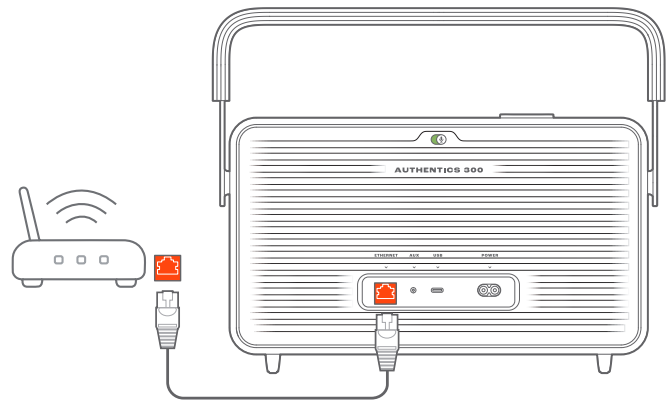

2. On your Android or iOS device, download and launch the JBL One app for music streaming and control.

NOTES:



- On your Android or iOS device, you can rename the speaker in the JBL One app.
- On your iOS device, add the speaker to the Apple Home app and manage it together with other AirPlay 2-compatible speakers.
- On your iOS device, if the speaker has been added to your home network, you can start AirPlay streaming from an AirPlay-compatible app (See [7.1.3 Play through AirPlay](#)).
- Availability of online music streaming services varies by country.
- Some features require subscriptions or services not available in all countries.

5.2 Connect to your Bluetooth device

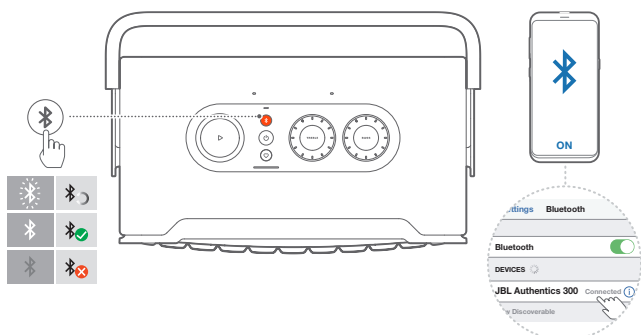
Through Bluetooth, connect the speaker with your Bluetooth device, such as a smartphone, tablet and laptop.



5.2.1 Connect a Bluetooth device

1. To select Bluetooth source, press .
 -  (Fast flashing white): Ready for Bluetooth pairing.
2. On your Bluetooth device, enable Bluetooth and search for “JBL Authentics 300” within three minutes.
 -  (Solid white): Successful connection.

5.2.2 To reconnect the last paired device

Your Bluetooth device is retained as a paired device when the speaker goes to standby mode. Next time you switch to the Bluetooth source, the speaker reconnects the last active device automatically.

5.2.3 To connect to another Bluetooth device

1. In the Bluetooth source, press .
 - The speaker enters the Bluetooth pairing mode.
2. Follow the Step 2 under “[5.2.1 Connect a Bluetooth device](#)”.

NOTES:

- This speaker supports multi-point connection. You can pair a second Bluetooth device without disconnecting the first one.
- The Bluetooth connection will be lost if the distance between the speaker and Bluetooth device exceeds 33 ft (10 m).
- Electronic devices may cause radio interference. Devices that generate electromagnetic waves must be kept away from the speaker, such as microwaves and wireless LAN devices.
- Voice commands are not supported in Bluetooth mode.

5.3 Connect to an external audio device

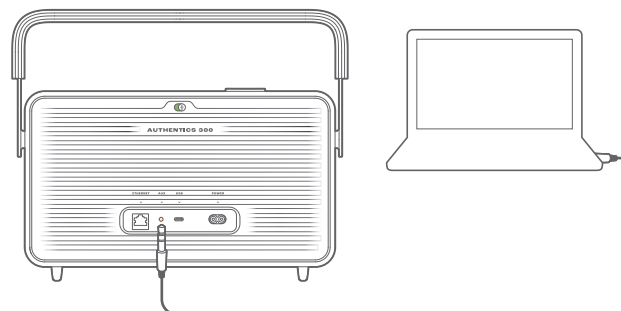

- Connect the speaker to an external audio device using a 3.5mm audio cable (sold separately), with one end connected to the AUX socket on the speaker, and the other end to the 3.5 mm audio output connector on the audio device.

NOTE:

- After the audio cable is connected, ensure that no music plays through Wi-Fi or Bluetooth to start music playback through the audio cable.

6. VOICE ASSISTANTS

6.1 Set up your voice assistants

With the JBL One app on your Android or iOS devices, set up Google Assistant, Alexa, or both.

- Follow the prompts to set up voice assistants in the JBL One app immediately after connecting the speaker to your home network (See “5.1 Connect to your home network”).
- If the speaker is already connected to your home network but has not completed the voice assistant setup, do the following:

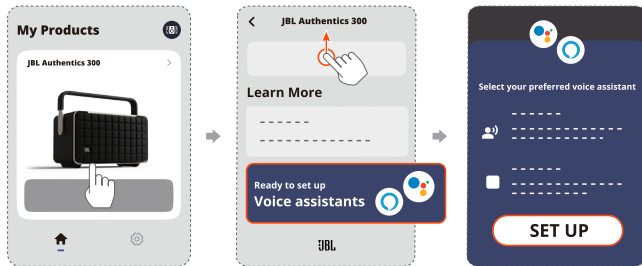

NOTE:

- Make sure your Android or iOS device is connected to the same Wi-Fi network as your speaker.

6.2 Talk to your voice assistants

With simultaneous voice assistants, ask either Google Assistant or Alexa to play music, get answers, manage everyday tasks, and control smart home devices using just your voice.

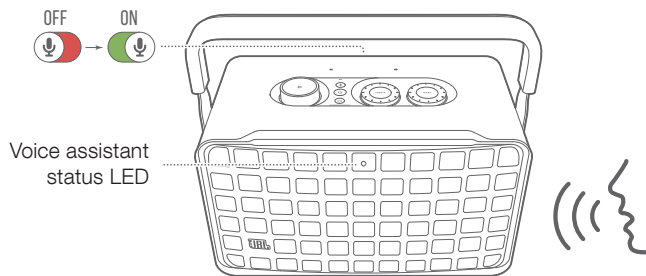

1. Make sure that the speaker has been properly connected to your home network and the microphone is turned on.
2. Just say “Hey Google” or “Alexa” to get started.

Examples:

- “Hey Google, play some music”
 - “Alexa, turn up the volume”
 - “Alexa, set a timer for 15 minutes”
 - “Hey Google, stop”
3. To suspend use of your voice assistant(s), turn the microphone off (🔴). To resume interaction with your voice assistant(s), turn the microphone on (🟢).

NOTES:

- For more information about Google Assistant and Amazon Alexa, please visit assistant.google.com or Amazon Alexa app.
- If you have set up Alexa or Google Assistant, but the microphone on the speaker is turned off, the voice assistants won't respond to voice commands until you turn the microphone on again.

7. PLAY

NOTES:

- To enable Chromecast built-in, Alexa Multi-Room Music, and Alexa Cast, please register Google Assistant and Amazon Alexa on the Google Home app and Amazon Alexa app respectively.
- The speaker can support audio streaming, but not video streaming.
- During music streaming through Chromecast built-in, Alexa Multi-Room Music, Alexa Cast, AirPlay, Bluetooth, or other streaming services enabled in the JBL One app, music playback will pause on the currently connected device when you start music playback on a second connected device.
- When the speaker switches between your home Wi-Fi and wired network during AirPlay, music playback will pause and resume in a few minutes, depending on broadband bandwidth conditions. For the connection to your home wired network, see “[5.1 Connect to your home network](#)”.

7.1 Play over your home network

Before you start, make sure that:

- your Android or iOS device is connected to the same Wi-Fi network as your speaker for music service streaming and control (See “[5.1 Connect to your home network](#)”).

7.1.1 Play through the JBL One app

Through the JBL One app, stream audio from enabled music services to the speaker.

1. On your Android or iOS device,
 - Launch the JBL One app, browse the available *music streaming services to select music, and then start music streaming to the connected speaker.



2. To exit from the music playback, switch to other sources.

NOTE:

- *Subscription may be needed and not provided by the JBL One app.

Access your presets with the ♥ (Moment) button

1. On the JBL One app,
 - Personalize the ♥ (Moment) feature.

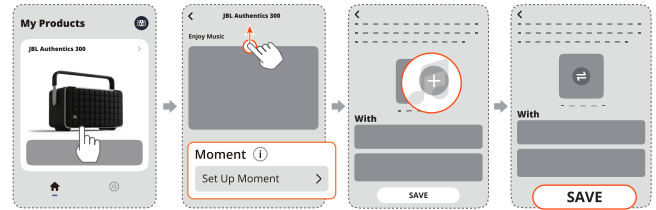

2. On the speaker,
 - Press ♥ to access the personalized playlist and speaker settings.

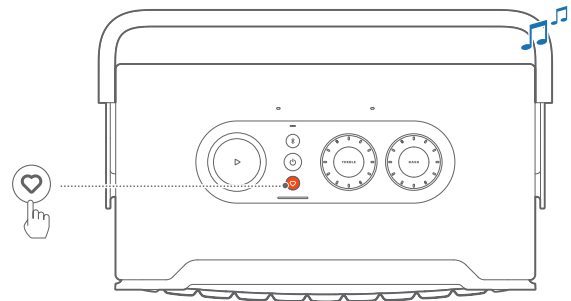

7.1.2 Play with Chromecast built-in

With Chromecast built-in, stream audio on your Android or iOS device to the speaker.

1. On your Android or iOS device,
 - a) Launch the JBL One app, and check that you have enabled Chromecast built-in.

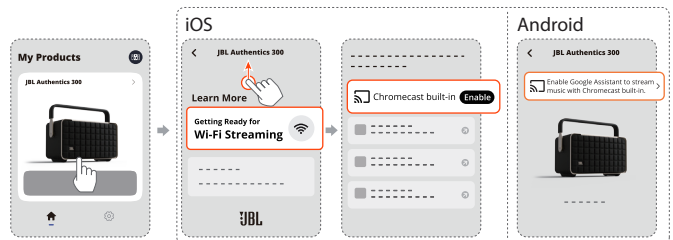

- b) On a Chromecast-enabled app, play music, tap the cast icon  and select the connected speaker.



2. To exit from the music playback, switch to other sources.

7.1.3 Play through AirPlay

Through AirPlay, stream audio on your iOS device to the speaker.

1. On your iOS device,
 - To enter the Control Center on an iOS device, swipe down from the upper right corner. Tap  to select the connected speaker, and then start audio streaming from an app.

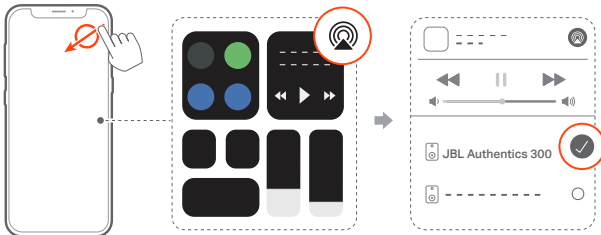

2. To exit from the music playback, switch to other sources.

7.1.4 Play through Alexa Cast

With the speaker connected to Alexa Cast, you can stream music from the Amazon Music library to the speaker.

1. On your Android or iOS device,
 - Launch the JBL One app, and check that you have enabled Amazon Alexa.



2. Launch the Amazon Alexa app to start music playback.
 - Open the Amazon Music app to access the Amazon Music library.
 - Make sure that you start music playback from the same Alexa account that you have enabled in the JBL One app. Refer to the Amazon Alexa app for more details.

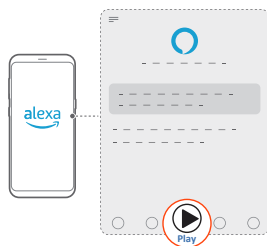

7.1.5 Multi-room playback

With the multi-room playback, you can stream music on your Android or iOS device to multiple Chromecast-enabled / AirPlay / Alexa speakers.

Chromecast built-in

1. Set up Google Assistant with Chromecast built-in in the Google Home app. Through the app, connect multiple Chromecast-enabled speakers to the same network, assign them to multiple rooms, and create groups as needed.
2. Run a Chromecast-enabled app on your smartphone or tablet.
3. Play music. Press  and select the grouped speakers.

NOTES:

- To create a multi-room speaker group in the Google Home app, make sure that you have connected all the speakers to the same home network and have used the same Google login account. Refer to the Google Home app for more details.
- Depending on the bandwidth of your local network, you can stream music to up to 6 Chromecast-enabled speakers.

AirPlay

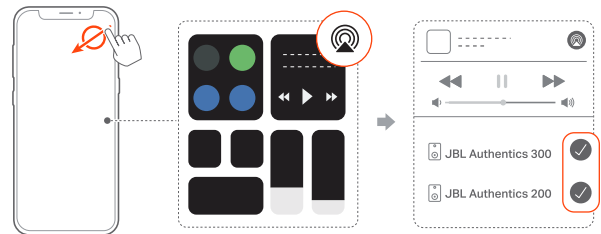

1. On an iOS device, enter the Control Center.
2. Tap  to select multiple connected speakers as needed.
3. Start music streaming from an app.

Alexa MRM: Multi-Room Music

1. Check that you have enabled Amazon Alexa on the speaker through the JBL One app.



- Through the Amazon Alexa app, create a multi-room music group for the speaker. Refer to the Amazon Alexa app for more information.

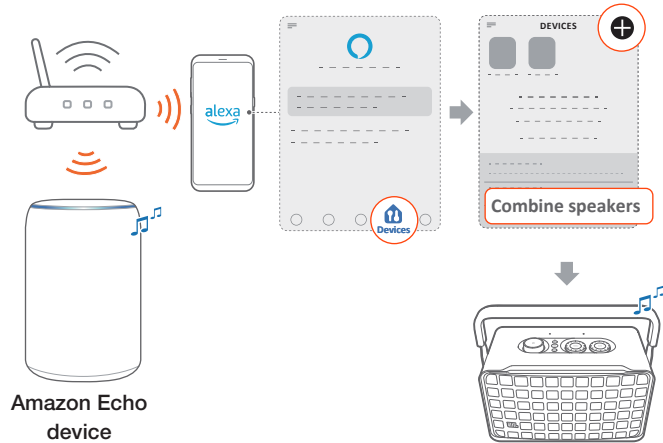



NOTE:

- To create a multi-room music group in the Amazon Alexa app, make sure that you have connected all the devices to the same home network and have used the same Alexa login account. Refer to the Amazon Alexa app for more details.

7.2 Play from the Bluetooth source

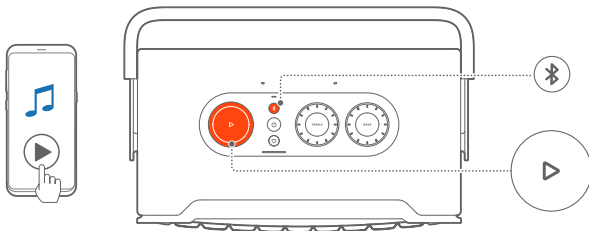
Through Bluetooth, stream audio play on your Bluetooth device to the speaker.



- Check that the speaker has been properly connected to your Bluetooth device (See [“5.2 Connect to your Bluetooth device”](#)).
- To select the Bluetooth source, press .
- Start audio play on your Bluetooth device.
 - Alternatively, press  on the speaker to control playback.



NOTE:

- Music streaming through Bluetooth will pause when you start music streaming through Wi-Fi.

7.3 Control music playback

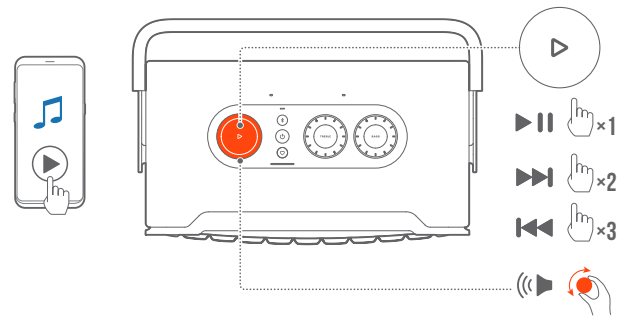
You can control music playback while streaming music from the JBL One app, Chromecast built-in, Alexa Multi-Room Music, Alexa Cast, AirPlay, or Bluetooth.



- Press  once to play or pause playback.
- Press  twice to skip to the next track.
- Press  three times to skip to the previous track.
- Rotate the volume knob clockwise or counterclockwise to increase or decrease the volume.

NOTE:

- Music control is unavailable in AUX mode.

7.4 Play from the AUX source

With a 3.5 mm audio cable, listen to music playback on an external audio device through the speaker.

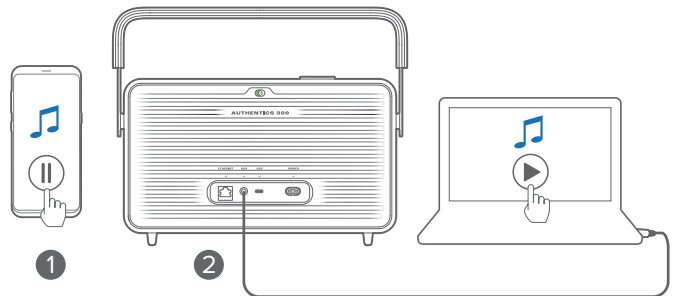

- Check that the speaker has been properly connected to the external audio device (See [“5.3 Connect to an external audio device”](#)).
- Check that you have paused music streaming over Bluetooth and your home network on the speaker.
- Start audio play on the external audio device.
- Adjust the volume on the external audio device or the speaker.

NOTE:

- If there is no audio output from the external audio device, try disconnecting and reconnecting the audio cable.

8. SETTINGS

8.1 Sound settings

8.1.1 Tone controls

With the JBL One app or the knobs on the speaker, you can adjust the Equalizer (EQ) settings to customize the sound.

- Option 1: On the speaker:

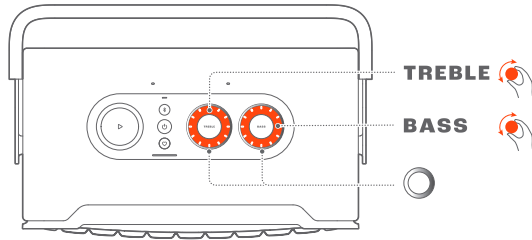

Default EQ setting

EQ	Default level	LED ring
TREBLE	6	
BASS		

- Option 2: Through the app:

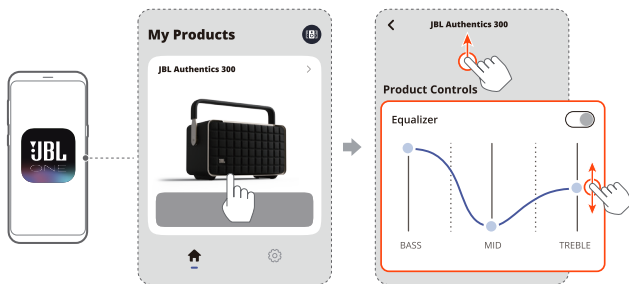

NOTE:

- The sound setting in the app and on the speaker will be synchronized.

8.1.2 Self-tuning

To optimize your sound experience for your unique listening environment, the speaker starts self-tuning automatically each time you connect the speaker to power and start music playback on the speaker. The self-tuning takes three minutes. If music playback stops before self-tuning is complete, the self-tuning will resume when you start music playback again.

NOTE:

- Automatic self-tuning will be disabled when the microphone is turned off.

8.2 Software upgrade



When the speaker is connected to the Internet via your home network and the battery level is more than 30%, the software of your speaker will automatically be updated to the latest version.

8.3 Hard reset

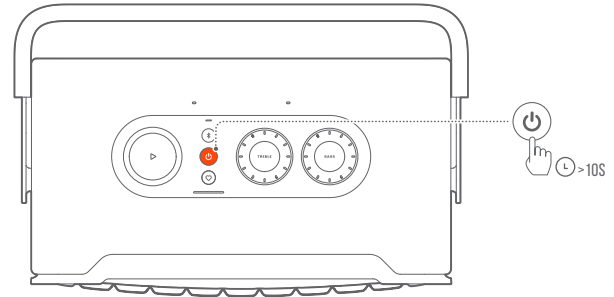
If the speaker does not respond to button presses, hold  for more than 10 seconds to reset the speaker.



8.4 Restore factory settings

On the speaker, hold  and  together for more than 10 seconds to restore the default settings programmed at the factory. When the factory reset is complete, the speaker will automatically power off and restart.

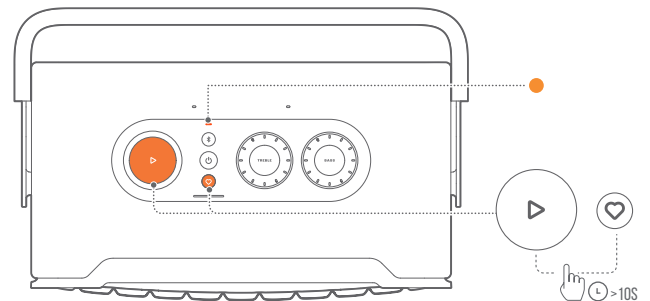

9. PRODUCT SPECIFICATIONS

General specification

- Model: Authentics 300
- Sound system: Stereo 2.0
- Power supply: 100 - 240V AC, ~ 50/60Hz
- Total speaker power output (Max @THD 1%): 100W
- Transducer: 2 x 25mm tweeter + 5.25" woofer
- Networked standby power: <2.0 W
- Operating temperature: 0 °C - 45 °C
- Lithium battery: 3.6V, 4800mAh
- Battery charge time: <3.5 hours
- Music play time: up to 8 hours (dependent on volume level and audio content)

Audio specification

- Frequency response: 45Hz - 20kHz (-6dB)
- Audio inputs: 1 Audio in, Bluetooth/Wi-Fi, Ethernet and USB (USB playback is available in US version. For other versions, USB is for Service only.)

USB specification

- USB port: Type C
- USB rating: 5V DC, 0.5A
- Supporting formats: mp3, WAV
- MP3 codec: MPEG 1 Layer 2/3, MPEG 2 Layer 3, MPEG 2.5 Layer 3
- MP3 sampling rate: 16 - 48 kHz
- MP3 bitrate: 80 - 320 kpbs

Wireless specification

- Bluetooth version: 5.3
- Bluetooth profile: A2DP 1.3.2, AVRCP 1.5
- Bluetooth transmitter frequency range: 2400 MHz - 2483.5 MHz
- Bluetooth transmitter power: <13 dBm (EIRP)
- Wi-Fi network: IEEE 802.11 a/b/g/n/ac/ax (2.4GHz/5GHz)
- 2.4G Wi-Fi transmitter frequency range: 2412 - 2472 MHz (2.4 GHz ISM Band, USA 11 Channels, Europe and others 13 Channels)
- 2.4G Wi-Fi transmitter power: <20 dBm (EIRP)
- 5G Wi-Fi transmitter frequency range: 5.15 - 5.35GHz, 5.470 - 5.725GHz, 5.725 - 5.825GHz
- 5G Wi-Fi transmitter power: 5.15 - 5.25GHz <23dBm, 5.25 - 5.35GHz & 5.470 - 5.725GHz <23dBm, 5.725 - 5.825GHz <14dBm (EIRP)

Dimensions

- Dimensions (W x H x D): 342 x 195.6 x 180.3 mm / 13.46" x 7.7" x 7.1"
- Weight: 4.9 kg / 10.8 lbs
- Packaging dimensions (W x H x D): 403 x 272 x 272 mm / 15.9" x 10.7" x 10.7"
- Packaging weight: 6.64 kg / 14.6 lbs

10. TROUBLESHOOTING

Never try to repair the product yourself. If you have problems using this product, check the following points before you request services.

For more troubleshooting tips, visit the support page at <https://product.jbl.com/AUTHENTICS-300.html>.

System

The unit will not turn on.

- Check if the power cord is plugged into power and the speaker.
- Check if the battery has enough power.

The speaker has no response to button presses.

- Reset the speaker by holding  for more than 10 seconds. The speaker will switch off and then switch on again.

Bluetooth

A device cannot be connected with the speaker.



- Check if you have enabled Bluetooth on the device.
- If the speaker has been paired with another Bluetooth device, re-enter the Bluetooth pairing mode (see "[5.2.3 To connect to another Bluetooth device](#)").

Poor audio quality from a connected Bluetooth device

- The Bluetooth reception is poor. Move the source device closer to the speaker, or remove any obstacle between the source device and the speaker.

Wi-Fi

Failed to connect to Wi-Fi.

- Make sure that Wi-Fi is turned on.
- Make sure that you have selected the right network and entered the correct password.
- Make sure that your router or modem is turned on and within the range.
- In your router settings, make sure that you have set the security type to WPA2 or auto.
- Make sure that your speaker is connected to the same wireless network as your smartphone or tablet.
- If you have difficulties in setting up Wi-Fi, hold  and  together on the speaker until the status indicator slowly pulses white.

Voice assistants

No response to the voice commands

- Check that you have connected the speaker to your home network (See [“5.1 Connect to your home network”](#)).
- Check that you have started voice control with the correct wake word (See [“6.2 Talk to your voice assistants”](#)).
- Depending on the location of your speaker, the ambient conditions may prevent the speaker from detecting the voice commands. Avoid placing the speaker in a noisy place or a place that is exposed to strong winds or echoes (sound reflections).
- Make sure that the built-in microphones are not turned off or covered.
- Speak closer to the microphones.

Playback



AirPlay cannot find the speaker as an AirPlay speaker for music streaming.

- On your Apple device, update the software to the latest version: iOS 13.4 and later, macOS 10.15.4 and later, or tvOS 14.3.
- Make sure that your Apple device has been connected to the same network as the speaker.
- For a PC running iTunes for Windows, you can stream music from your PC to the speaker through Bluetooth.

Music playback does not work smoothly when the sound source switches from Bluetooth to Chromecast built-in, AirPlay or Alexa.

- The quality of audio casting and playback are dependent on the traffic and coverage of the network that connects the speaker and your casting devices, such as phones, tablets and PCs.

The speaker is in the “Offline” status in the Amazon Alexa app or there are problems with Alexa MRM-related playback.

- To recover the speaker, restore the speaker to its factory settings by holding  and  together for more than 10 seconds.

No music playback on the Audio In source when the sound source switches from Bluetooth to Audio In.

- Disconnect and reconnect the 3.5mm audio cable to the speaker.

11. TRADEMARKS



The Bluetooth® word mark and logos are registered trademarks owned by Bluetooth SIG, Inc. and any use of such marks by HARMAN International Industries, Incorporated is under license. Other trademarks and trade names are those of their respective owners.



Wi-Fi CERTIFIED 6™ and the Wi-Fi CERTIFIED 6™ Logo are trademarks of Wi-Fi Alliance®.



Google, Android, Google Play, and Chromecast built-in are trademarks of Google LLC.

Google Assistant is not available in certain languages and countries. Availability and performance of certain features, services, and applications are device and network dependent and may not be available in all areas.



Amazon, Alexa and all related marks are trademarks of Amazon.com, Inc. or its affiliates.

Alexa is not available in all languages and countries.



Use of the Works with Apple badge means that an accessory has been designed to work specifically with the technology identified in the badge and has been certified by the developer to meet Apple performance standards.

Apple, and AirPlay are trademarks of Apple Inc., registered in the U.S. and other countries.

To control this AirPlay 2-enabled speaker, iOS 13.4 or later is required.



Use your phone, tablet or computer as a remote control for Spotify. Go to spotify.com/connect to learn how.

The Spotify Software is subject to third party licenses found here: <https://www.spotify.com/connect/third-party-licenses>.

12. OPEN SOURCE LICENSE NOTICE

This product contains open source software licensed under GPL. For your convenience, the source code and relevant build instruction are also available at https://harman-webpages.s3.amazonaws.com/Harman_One_OS_A_package_license_list.htm.

Please feel free to contact us at:

Harman Deutschland Gmb

HATT: Open Source, Gregor Krapf-Gunther, Parking 3

85748 Garching bei Munchen, Germany

or OpenSourceSupport@Harman.com if you have additional question regarding the open source software in the product.



HARMAN International Industries,
Incorporated 8500 Balboa Boulevard,
Northridge, CA 91329 USA
www.jbl.com

© 2023 HARMAN International Industries, Incorporated.
All rights reserved.

JBL is a trademark of HARMAN International Industries, Incorporated, registered in the United States and/or other countries. Features, specifications and appearance are subject to change without notice.